



OKI

MEDICAL SUPPLY UNITS



LM MEDICAL
DIVISION

LM MEDICAL DIVISION

Founded by the Lancini family, LM MEDICAL DIVISION is the thriving result of more than 30 years of expertise in the industrial power units and electromedical equipment. The recently born international brand, specialized in medical supply units for foreign countries, has been witnessing an unrestrained growth especially over the past recent years.



We are a full-service supplier in electromedical equipment, privacy solutions and wall protections. We offer full assistance, thoughtful planning, step-by-step development, efficient production and installation, careful maintenance and reliable servicing.

Attention to detail together with our unceasing search for up-to-date functioning design embraces a remarkable technical know-how; this winning attitude has allowed us to develop high-quality equipment for the various functions needed in the modern healthcare.

Our headquarters host all departments, from designing and technical planning to all main production processes. We strongly believe that in order to offer an accurate customizable product, project development and all further steps in the supply chain need the most attentive and close monitoring. This is also the only way we can guarantee that each part matches perfectly and we can step in to make on-the-spot corrections if needed.



All LM MEDICAL DIVISION products are made exclusively in Italy and all semifinished products and components in supply are solely of Italian or German output. We only use the very best materials and technologies in our manufacturing as quality represents for us a binding commitment to all our customers.



Putting quality into the foreground means for us to enrich our company with an extremely skilled and dutiful staff striving for customer's complete satisfaction. Choosing LM MEDICAL DIVISION means to have a trained team capable to achieve the most ambitious projects, customizable to the very smallest detail. What is making our company unquestionably up to the very best international standards is the tangible capability to tailor offerings to our customers. From technical layouts to finishing touches everything can be adapted and installed according to whichever request.



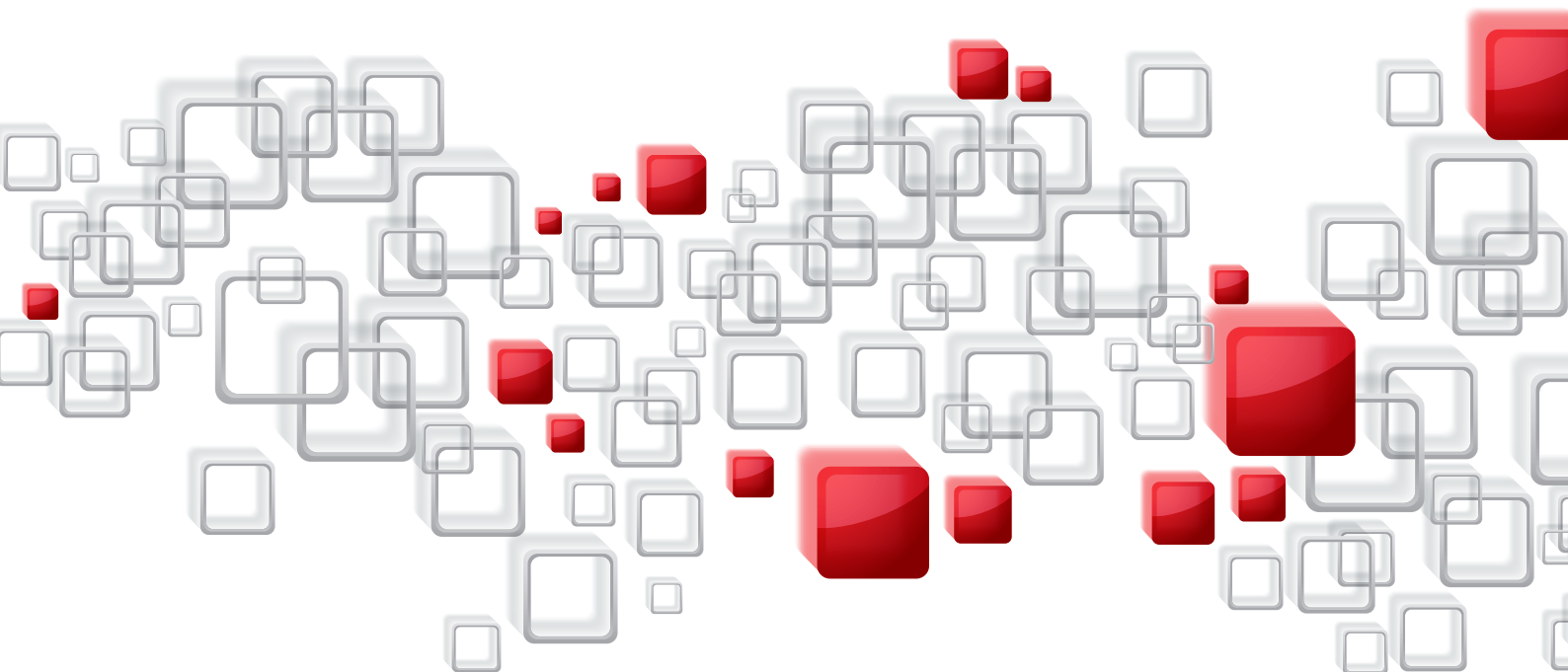

OKI EXPERIENCE

LM Medical Division's vast experience in the electro medical equipment industry makes it a key partner in the supply of bed head units for the medical and hospital sector.

LM Medical Division's OKI line is the result of the analysis, research, design and manufacture of high quality bed head units, using state of the art design and manufacturing technology. OKI bed heads are made 100% in Italy and have a user-friendly, practical design, to guarantee optimal use and durability in healthcare facilities. . All OKI models are made of extruded aluminum profiles and high-tech materials assembled to a choice of several configurations. They have the following features:

- The Smooth regular surfaces are an advantage guaranteeing easy cleanliness and disinfection;
- The lenght of the BHU can be fully customized to each customer's request;
- Location of gas outlets and electrical components can be adapted to each customer's specific need;

The OKI bed head units range offers different characteristics depending on the specific functions required by the client.

OKI RANGE



OKI BASIC

PG - 5



OKI BASIC GAS ES

PG - 6



OKI BASIC GAS MD/LG

PG.7 > 8



OKI PLUS ES

PG - 9 > 10

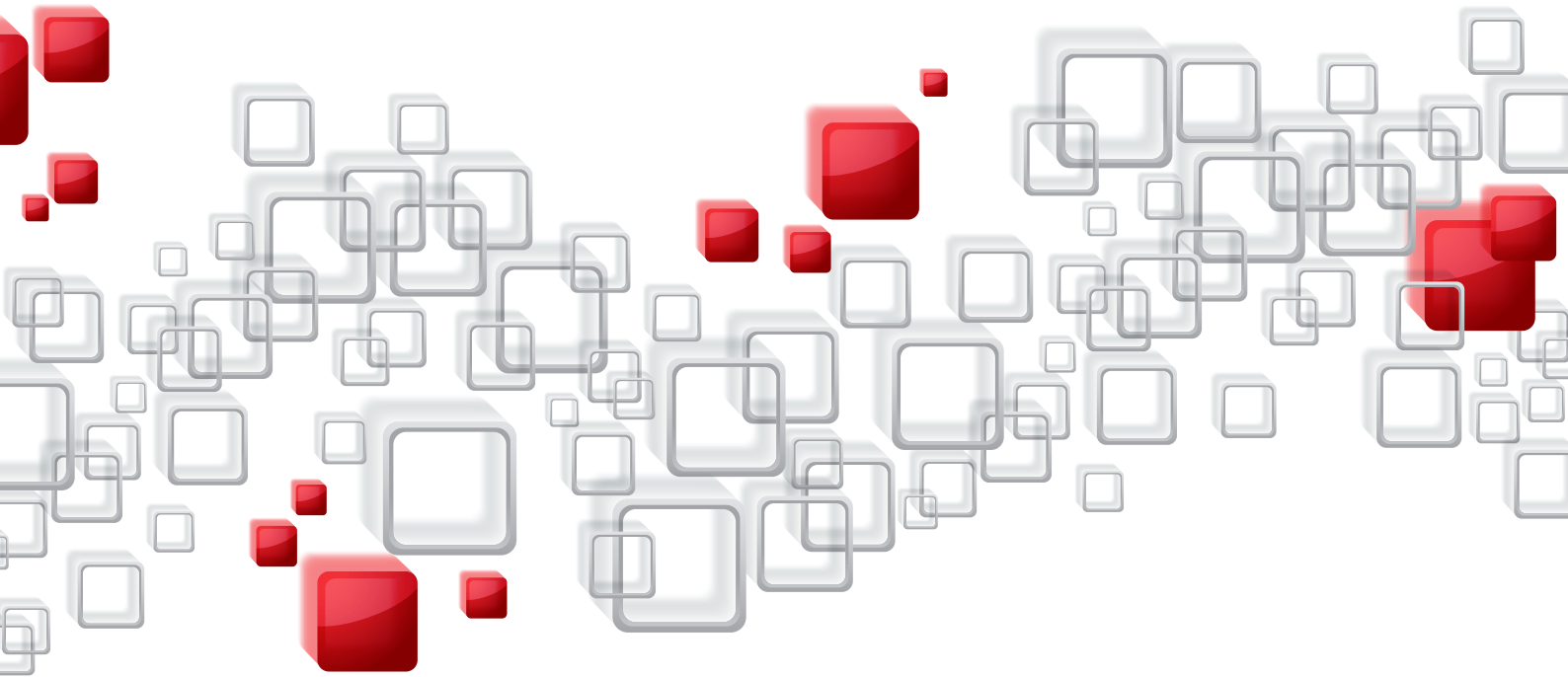

OKI PLUS MD/LG

PG - 11 > 12



OKI DESIGN

PG - 25 > 26



OKI VERTICAL

PG - 13 > 14



OKI FLAT

PG - 27 > 28



OKI CIELO

PG - 15 > 18

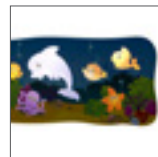

OKI FANTASY

PG - 29



OKI ISOLA

PG - 19 > 21



COLOURS & FINISHINGS

PG - 30



COLOURS & FINISHINGS

PG - 22

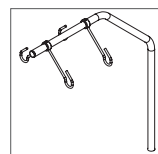

ACCESSORIES

PG - 32



OKI INFINIT-I

PG - 23 > 24



CERTIFICATIONS

PG - 33 > 34

BASIC - WALL MOUNTED



INTRODUCTION

OKI BASIC is our medical supply unit, particularly suited for day-hospital and outpatient care.

It offers an unpretentious design which is easily adaptable to all standard care units.

The profile can be equipped with a full range of electrical sockets and switches, according to each customer's detailed specification.

OKI BASIC is not designed to house gas outlets.



Upon request are available for all basic gas models LED spotlights for direct lighting.

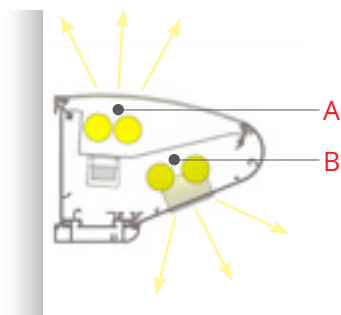

LIGHT DIFFUSION

A - INDIRECT LIGHT

B - DIRECT LIGHT

BASIC GAS - ES WALL MOUNTED



INTRODUCTION

OKI BASIC GAS ES is highly recommended for both outpatient and inpatient care.

It has been designed to provide separated profiles for gas outlets and electrical components in compliance with the international health and safety regulations. The profile can be equipped with a full range of electrical sockets and switches, according to each customer's detailed specification.



The gas box can house up to 4 outlets. It is attached to the main profile and can be screwed onto the wall.

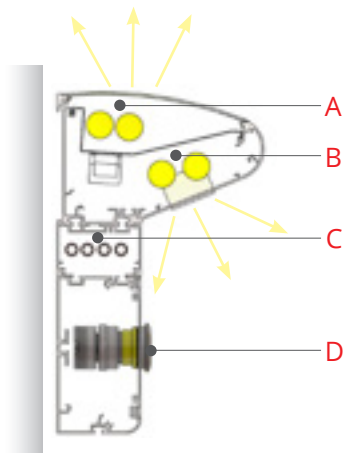

LIGHT DIFFUSION

- A - INDIRECT LIGHT
- B - DIRECT LIGHT

COMPONENTS

- C - GAS PIPING
- D - GAS OUTLET

BASIC GAS - MD/LG WALL MOUNTED



INTRODUCTION

OKI BASIC GAS MD AND LG are highly recommended for inpatient care.

They have been designed to provide a single or double profile where gas outlets and electrical components are always kept separated in compliance with the international health and safety regulations.

The profiles can be equipped with a full range of electrical sockets and switches, data entry plug-ins according to each customer's detailed specification.

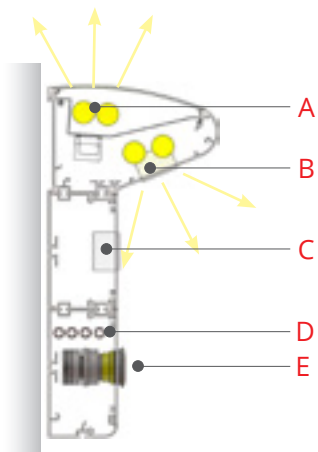

LIGHT DIFFUSION

- A - INDIRECT LIGHT
- B - DIRECT LIGHT

COMPONENTS

- C - ELECTRICAL COMPONENTS
- D - GAS PIPING
- E - GAS OUTLET



Upon request DIN RAIL is also available for BASIC GAS MD/LG and all PLUS models.

BASIC GAS - MD/LG CEILING MOUNTED



INTRODUCTION

Both OKI BASIC GAS MD/LG are also available with lateral columns to offer a pendant solution for all intensive wards where special equipment and appliances can be connected suitably to the main trunk so that these are always at hand when needed.

These ceiling mounted versions are especially recommended for rooms with extended windows.



PLUS - ES WALL MOUNTED



INTRODUCTION

OKI PLUS ES is designed and recommended to offer an easy and priceworthy solution for standard inpatient care. The bed head unit could be supplied with indirect and direct lighting and can house all medical gas outlets separately from the electrical components.

The highly adaptable profile can be configured for all special hospital wards.



Depending from the profile's length a specific quantity of electrical and gas components can be installed.

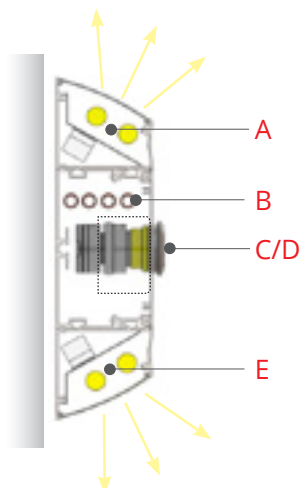

LIGHT DIFFUSION

- A - INDIRECT LIGHT
- E - DIRECT LIGHT

COMPONENTS

- B - GAS PIPING
- C - GAS OUTLET
- D - ELECTRICAL COMPONENTS



PLUS - RECESSED



INTRODUCTION

Oki PLUS ES can be also recessed into the wall. Especially suitable for wards where sleek but simple design needs to meet all medical requirements for standard specialty wards.



The profile is suitably screwed into an aluminum frame which is walled in, offering a smooth regular surface.

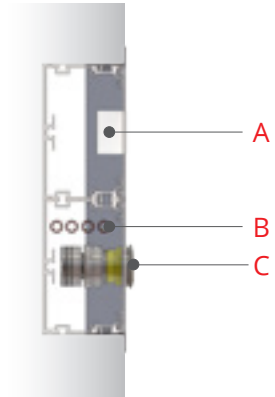

- COMPONENTS**
 A - ELECTRICAL COMPONENTS
 B - GAS PIPING
 C - GAS OUTLET

PLUS - MD/LG WALL MOUNTED



INTRODUCTION

OKI PLUS MD/LG models are particularly designed for intensive care units. Gas and electrical components are kept separated by two or even three different profiles. This models give the opportunity to equip the bed head unit thoroughly according to the most detailed requirements. .

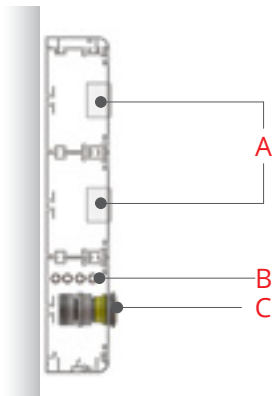

COMPONENTS

- A - ELECTRICAL COMPONENTS
- B - GAS PIPING
- C - GAS OUTLET



Available upon request the useful direct and indirect lighting options and the DIN RAILS onto which a broad range of accessories can be installed.

PLUS - MD/LG CEILING MOUNTED

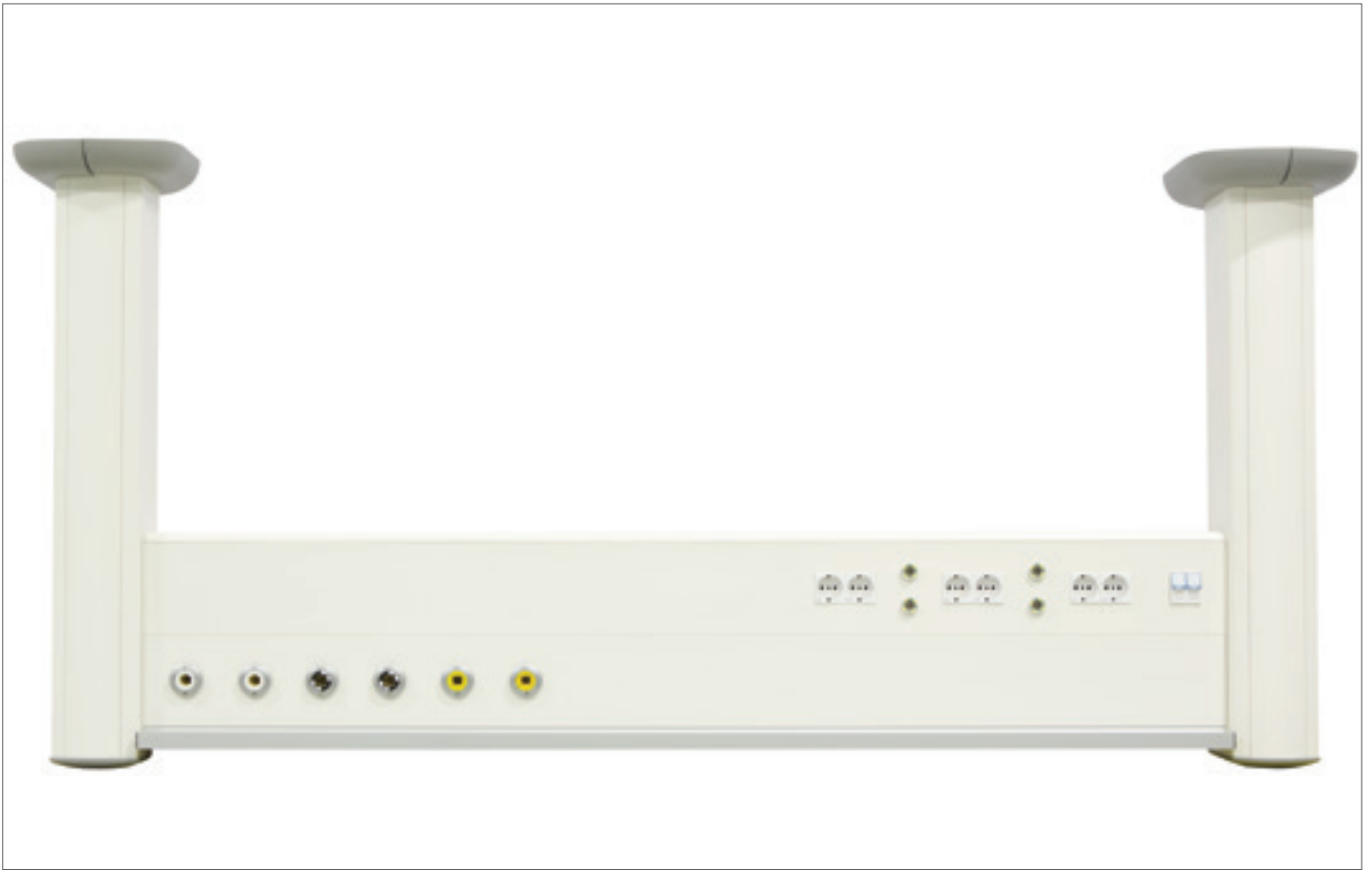

INTRODUCTION

Similarly to Oki Basic Gas intensive care options, OKI PLUS MD/LG can be ceiling mounted thanks to the lateral columns. This allows us to cope with all different requests not only on a technical but also on a stylistic point of view.



VERTICAL - WALL MOUNTED



INTRODUCTION

VERTICAL unit is ideal for both standard special care and intensive units. Designed to supply both single and double beds, its offers a practical option for the medical staff who can easily avail of the main electrical sources and medical gasses. It can be fully configured with a number of electrical sockets, data sockets, gas outlets according to the most detailed requirement.



Available upon request one or two vertical poles onto which a number of dedicated accessories can be installed.

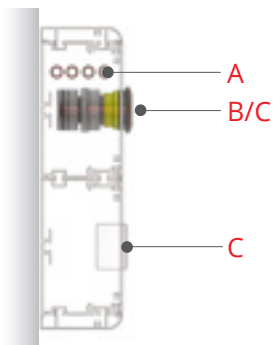

COMPONENTS

- A - GAS PIPING
- B - GAS OUTLET
- C - ELECTRICAL COMPONENTS



VERTICAL- COLUMN



INTRODUCTION

Our VERTICAL model like the rest of the broad OKI range offers not only the standard wall mounted configuration but also the possibility to fix it directly on the ceiling. VERTICAL COLUMN is not free-standing solution and it rests on the floor. The pendant solution is incredibly adaptable, offering absolute versatility and practicality. Mainly thought for standard specialty wards it can be single or double-sided supplying up to 4 different single beds at the same time.

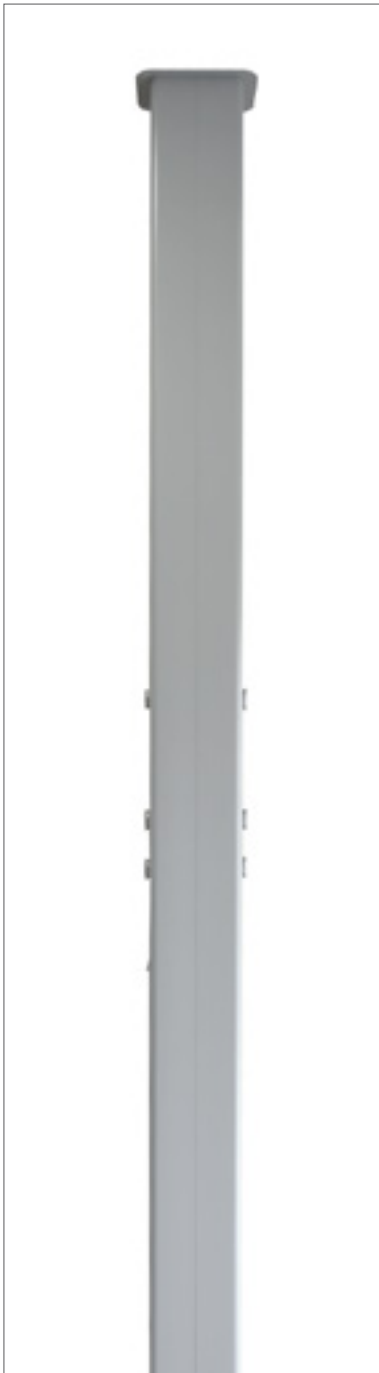

The ceiling plate is designed to fit perfectly around the column which slides into the ceiling surfaces.

CIELO - CEILING MOUNTED



INTRODUCTION

OKICIELO is a ceiling mounted bed head beam fitted with lighting, provision for medical gases, electrical switches and sockets. The system has been designed for intensive care units, preparation and recovery rooms which require several sockets and switches to supply medical equipment such as monitors, dialysis machines, respirators and other machines required to keep the patient alive. Both sides of the unit can be equipped with the medical equipment. Trolleys with shelves and instrument trays can be fitted to the unit, holding considerable weights.

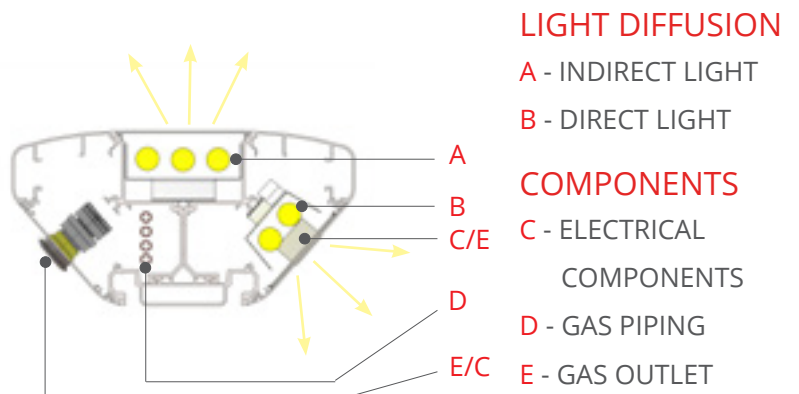

CUSTOMIZATION

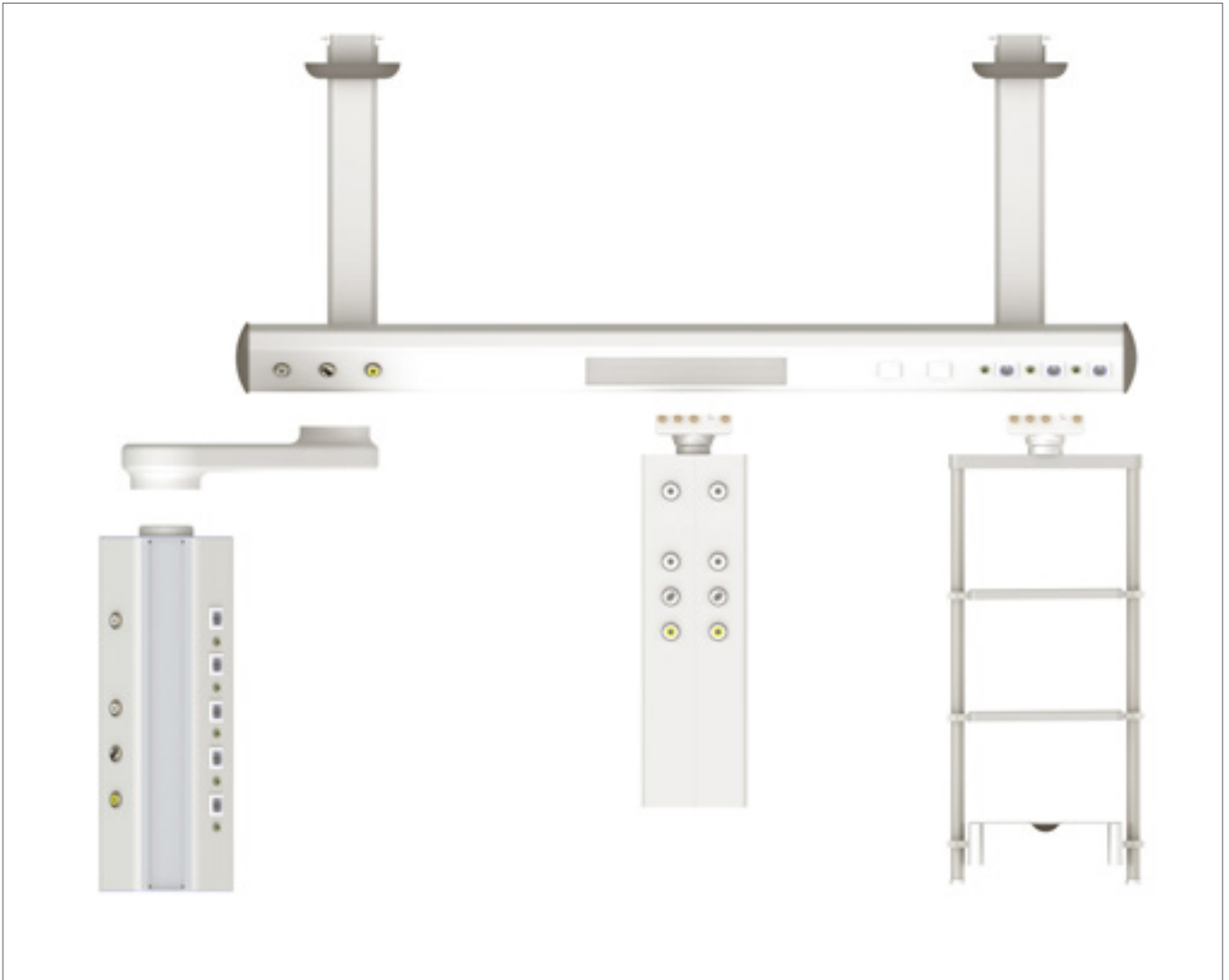

OKI CIELO can be fully customized with additional components. A wide range of dedicated accessories is available upon request.



CIELO - VERTICAL WALL MOUNTED



INTRODUCTION

OKI CIELO is also available in the vertical wall mounted solution. Studied for intensive care units, this bed head unit offer maximum versatility allowing the medical staff to use all the needed equipment with extreme ease. Available upon request the stainless steel vertical pole onto which a number of accessories can be combined.



Highly recommended the 38mm stainless steel vertical pole onto which dedicated accessories can be installed.

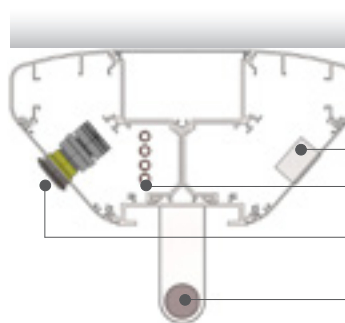

- COMPONENTS**
- A - ELECTRICAL COMPONENTS
 - B - GAS PIPING
 - C - GAS OUTLET
 - D - VERTICAL POLE



CIELO - CEILING COLUMN



INTRODUCTION

CIELO bed head unit is LM Medical division's greatest example of how technical know-how and responsible attitude to strive for the best results coalesce harmoniously. In fact CIELO can be also offered in free-standing configuration, fixed on the ceiling through a solid pillar. In this way CIELO can be mounted anywhere in the room with a wide range of accessories and rotating equipment carries making this bed head unit the ideal solution for special intensive care units.

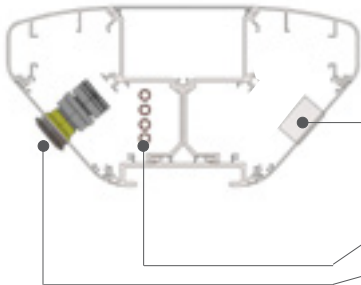

COMPONENTS

- A - ELECTRICAL COMPONENTS
- B - GAS PIPING
- C - GAS OUTLET

A/C
B
C/A

ISOLA



INTRODUCTION

OKI ISOLA supply system is a suspended unit thought specifically for special intensive care units and operating theaters. It is configured with one or two swiveling and adjustable arms to support a rotating head equipped with all the electrical and medical components. It has been designed to offer the medical staff maximum manoeuvrability and perceptiveness.

Oki ISOLA is available with a number of shelves and drawers which can be installed along onto the main column. There are available different versions that can be fully customized according to any specific request. Also available a number of dedicated accessories.



ISOLA - *MOTORIZED*



MAIN HEAD STRUCTURE

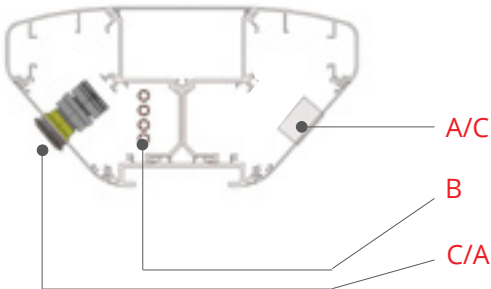

COMPONENTS

- A - ELECTRICAL COMPONENTS
- B - GAS PIPING
- C - GAS OUTLET

INTRODUCTION

OKI ISOLA is also available with a full motorized mechanism. The hydraulic breaking system guarantees maximum stability, accuracy and ease of any movement.



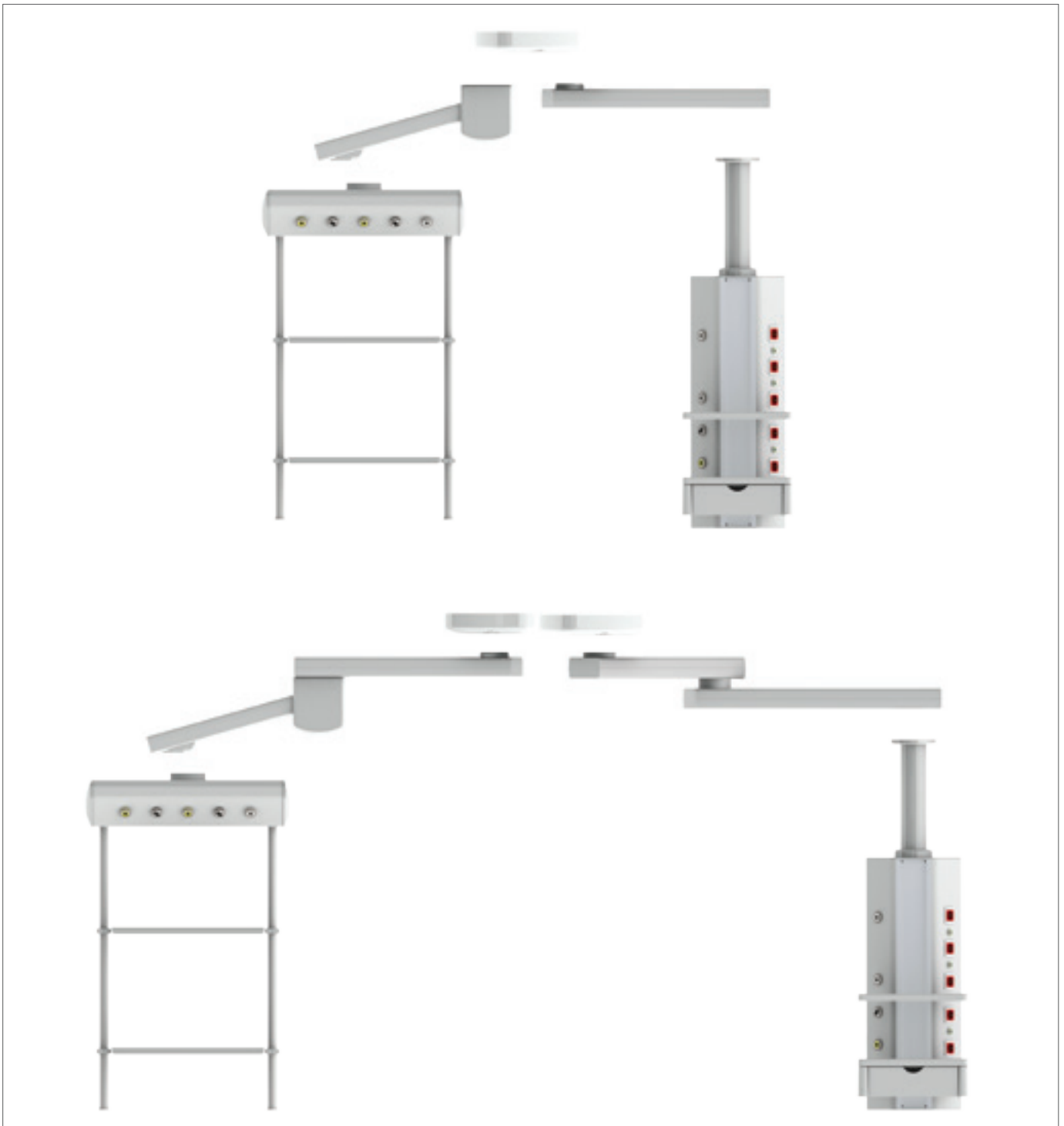

CUSTOMIZATION



OKI ISOLA can be fully personalized with a broad range of accessories. Special rail supports or vertical poles are available for installing all the needed complementary equipment to monitor the patient's vital signs.

OKI ISOLA allows fast operations by making it easier for the medical staff to use the equipment, guaranteeing an optimal care to each patient.

COLOURS AND FINISHING

	 RAL COLOUR	 ANODIZED	 WOOD FINISHING	 ANTIBACTERIAL TREATMENT	 SPECIAL FANTASIES
OKI BASIC	●	●	●		
OKI BASIC GAS ES	●	●	●	●	●
OKI BASIC GAS MD/LG	●	●	●	●	●
OKI PLUS ES	●	●	●	●	●
OKI PLUS MD/LG	●	●	●	●	●
OKI VERTICAL	●	●		●	
OKI CIELO	●	●		●	
OKI ISOLA	●			●	

ILLUSTRATIVE COLOUR CHART FOR ALUMINUM PROFILES



The colours shown are for guidance only, please refer to the standard RAL colour chart.
 The choice of any colour not commonly used might require longer delivery time.
 Customers are highly recommended to consult our sales office for detailed advice.
 Special anti-bacterial paint is also available upon request, suggested for intensive care units.

SPECIAL FINISHINGS

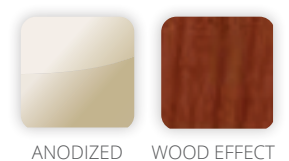

Please contact us to receive the full range of available finishings.

INFINIT-I - WALL MOUNTED



INTRODUCTION

OKI INFINIT-I is the result of our passion for design and functionality. The newly developed profile separates the forward-facing gas outlets from the down-facing electrical ones which are placed in the lower section. The front panel is made of polycarbonate or methacrylate which can be offered in solid colours or special patterns.

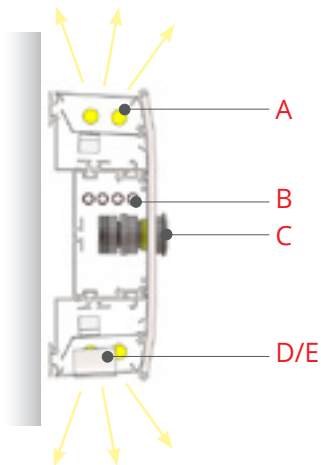

LIGHT DIFFUSION

- A - INDIRECT LIGHT
- E - DIRECT LIGHT

COMPONENTS

- B - GAS PIPING
- C - GAS OUTLET
- D - ELECTRICAL COMPONENTS

INFINIT-I BELONGS TO THE OKI PLUS CE CERTIFICATION



INFINIT-I - VERTICAL WALL MOUNTED



INTRODUCTION

Looking for as many solutions as possible led us to configure OKI INFINIT-I vertically. We wanted to give the option to have a more stylish appeal for the patient's rooms. OKI INFINIT-I really stands out for the refined design and remarkable personalization.



DESIGN - WALL MOUNTED



OKI DESIGN can be equipped with the following optionals :

- A set of drawers nicely fitted on the main unit;
- Single or double vertical poles;
- A pullout telescopic curtain as privacy solution.

INTRODUCTION

The modern and sleek design is the outstanding feature of the OKI DESIGN model. Designed and suggested for V.I.P. rooms, OKI DESIGN stands out thanks to its sophisticated and elegant style. The bed head unit has a fireproof HPL laminated wood panel easy to clean and disinfect. This vertical solution could supply at the same time two separated beds. It has optional gas outlets for medical gas supply, as well as sockets, switches and nurse call controls. OKI DESIGN may be also supplied with drawers and a curtain for privacy reasons. It cannot house indirect and direct lighting. A broad choice of finishings is available in order to personalize it to the very refined taste of each customer.



Available upon request this version of the OKI DESIGN can be supplied with the privacy curtain.



COMPONENTS

- A - GAS PIPING
- B - GAS OUTLET
- C - ELECTRICAL COMPONENTS

DESIGN - ART



INTRODUCTION

One of the last results of LM Medical Division's unceasing search of the very up-to-date and fashionable style is this polycarbonate version of the DESIGN bed head unit.

The attempt to find a modern interpretation of the former classical wooden look led us to develop a sleek panel that can be personalized in colours and refined finishing options.

DESIGN can be fully equipped with electrical components and gas outlets like the other version. Lighting diffusion is not available on this model apart from the night one, which can be supplied on request.

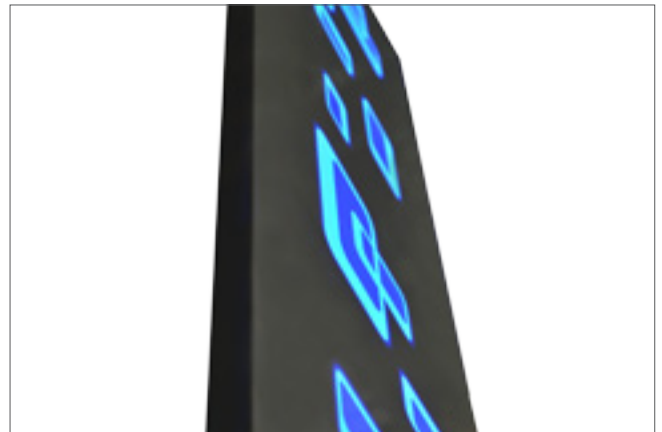

The unique feature of this OKI DESIGN version is the sophisticated backlighting. Please ask for dedicated catalogue with all the available finishings and special patterns.

FLAT - WALL MOUNTED



INTRODUCTION

The OKI FLAT is made of fireproof HPL laminated wood panels easy to clean and disinfect. The OKI FLAT power supply system for medical use does not come with the lighting system, but it can house LED for night vision, as well as RGB LED. The device may be fitted with gas outlet for medical gas supply, as well as sockets, switches and data ports.



OKI FLAT may also be fitted with a state-of-the-art touch screen tablet management system, to make the hospital stay more comfortable and allowing the patient to connect to the web. Thanks to a specifically designed software programme, physicians and medical operators may also use the tablet, if available in the hospital, to manage the clinical record of every patient.

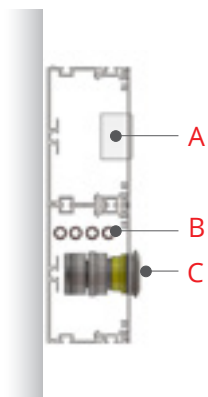

COMPONENTS

- A** - ELECTRICAL COMPONENTS
- B** - GAS PIPING
- C** - GAS OUTLET



FLAT - ART

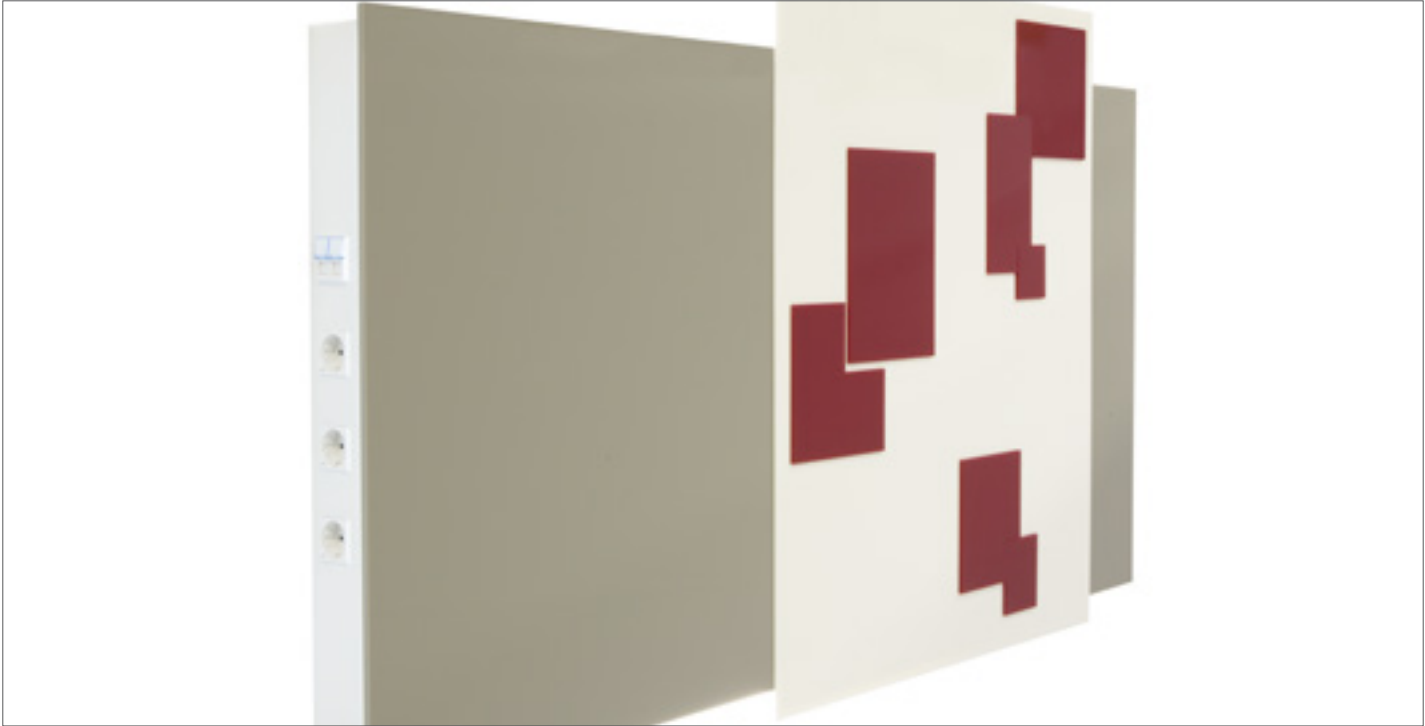

INTRODUCTION

Our unceasing search to offer the best design led us to create this latest version of OKI FLAT. A remarkable combination of polycarbonate or methacrylate panels, a number of possible customizable patterns for the central body and a newly developed profile housing separately on both sides gas outlets and electrical equipment resulted in this state-of-the-art bed head unit.

This latest version is ideal for those special VIP rooms where design must meet the latest needs in terms of innovation.



FANTASY - WALL MOUNTED



INTRODUCTION

LM MEDICAL DIVISION has been working non-stop to improve and enlarge the product range. OKI FANTASY is one of our sensible examples of how up-to-the-minute technology meets the need of the paediatric wards. Designed to make children’s recovery more pleasant, OKI FANTASY is made of an innovative polycarbonate sheet onto which it is applied a colourful film, featuring cartoons.

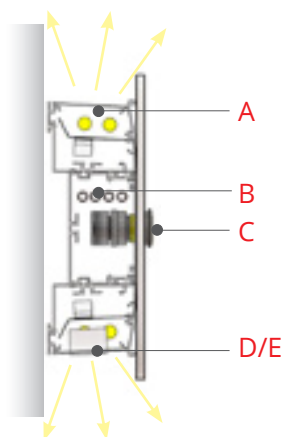
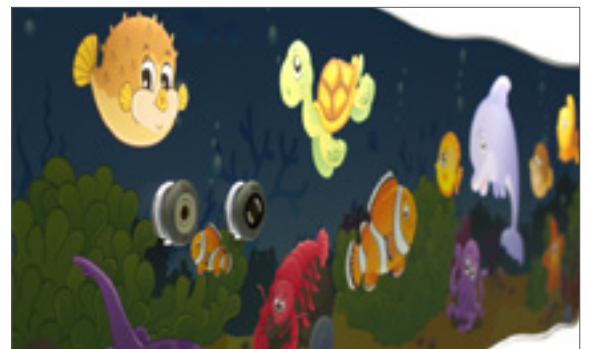

LIGHT DIFFUSION

- A - INDIRECT LIGHT
- E - DIRECT LIGHT

COMPONENTS

- B - GAS PIPING
- C - GAS OUTLET
- D - ELECTRICAL COMPONENTS

Upon request OKI FANTASY is supplied with a fancy night backlighting. Please ask for the dedicated catalogue to check the available personalizations.

COLOURS AND FINISHING

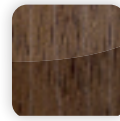

	LATERAL ALUMINUM PROFILE	POLYCARBONATE PANEL	HP LAMINATED WOOD PANEL	SPECIAL PATTERNS	SPECIAL FANTASIES
OKI INFINIT-I	●	●		●	
OKI DESIGN	●	●	●	●	
OKI FLAT	●	●	●	●	
OKI FANTASY	●				●

ILLUSTRATIVE COLOUR CHART FOR ALUMINUM PROFILES



1023 GLOSSY 9010 MAT 9006 MAT 5005 MAT



1013 GLOSSY 2002 GLOSSY 6019 GLOSSY 5024 GLOSSY

FRONT POLYCARBONATE PANELS:

SOLID COLOURS FOR ALL PANELS



900 360 7560 3610 2311 4380 1510 1670 5620

HPL LAMINATED WOOD



B026 PURE WHITE FA42 COMFORT FA45 GUERRILLA FA33 MAYA BRONZE UA59 BORDEAUX



LK48 LEUCA WALNUT LK97 MAGISTER OAK LG23 WHITENED OAK LK84 OREGON PINE LA58 LARIO WALNUT LK66 MAPPLE WOOD LA79 CHERRY WOOD LG14 DARK OAK

The colours shown are for guidance only, please refer to the standard RAL colour chart and to our swatch cards for the finishings.

The choice of any colour not commonly used might require longer delivery time. Customers are highly recommended to consult our sales office for detailed advice.



EC CERTIFICATE TRADEMARKS

The CE trademark certifies that the product has met all relevant European regulations.



EC CERTIFICATE TRADEMARKS 0051

The CE trademark certifies that the product has met all relevant European regulations. Our medical supply units are medical devices (class IIb) in compliance with the Directive 93/42/EEC based on the quality management system and EN ISO 13485.



GOST CERTIFICATE TRADEMARK

The Gost trademark guarantees that the product is in accordance with the effective Russian regulations.



GAS OUTLETS

The medical supply unit can house a number of gas outlets which could be of whichever specific standard required by the end user. Upon request pre-piping with certified copper is available.

STANDARD	COUNTRY
AFNOR NF S 90-116	FRANCE
BS 5682:1998	U.K.
DIN 13260-2	GERMANY
ENV 737-6	EUROPE
NFPA 99	U.S.A.
SS 875 24 30	SWEDEN
UNI 9507	ITALY

Other standards are available upon request.



DATA COMMUNICATION

The medical supply unit can be equipped with dedicated slots for data transmissions such as nurse call, sound diffusers RJ data sockets, etc.



NIGHT LIGHTING

The medical supply unit can be equipped with dedicated a subdued night lighting, guaranteeing to both patients and medical staff a pleasant and safe environment during the overnight hours.



INDIRECT LIGHTING

The medical supply unit can be equipped with ambient lights, guaranteeing an adequate artificial lighting for all hospital wards. Depending upon each customer's request we can supply both fluorescent T16-T26 lights. Also available upon request light-dimming switches.



DIRECT LIGHTING (READING-EXAMINATION)

The medical supply unit can be equipped with direct reading and examination lights, guaranteeing to both patients and medical staff sufficient artificial lighting for all hospital wards. Depending upon each customer's request we can supply both fluorescent T16-T26 lights. Also available upon request light-dimming switches.



LED LIGHTING

Available upon request all lighting can be offered with LED stripes or LED spotlights.



SINGLE/DOUBLE DIN RAIL

The medical supply unit can be equipped with single or double DIN rail. It is made of anodized aluminum 25x10 in compliance with CE regulations. A series of accessories can be combined with the DIN rails.



SINGLE/DOUBLE VERTICAL POLE

The medical supply unit can be equipped with single or double vertical pole. It is made of stainless steel with a variable diameter of 25/38 mm and anodized aluminum supports which can be fixed or swiveling. The load capacity can be adjusted according to the customer's request. A series of accessories can be combined with the vertical poles.



ANTIBACTERIAL PAINT TREATMENT

The medical supply unit can be supplied with epoxy-polyester antibacterial paint. This finishing is thought for all those special intensive wards where the environment must be as much aseptic as possible.



AVAILABLE OKI ACCESSORIES

The medical supply unit can be completed with a broad list of accessories. Please refer to our ACCESSORIES SECTION for more detailed information.



SPECIAL PATTERNS AVAILABLE

The front cover of the medical supply unit can be personalized with the following patterns and fantasies:



STANDARD SPECIALITY WARD

The medical supply unit is recommended for wards providing standard levels of treatment and medical/nursing care.



INTENSIVE CARE UNIT

The medical supply unit is recommended for units (ccu, icu, nicu, resuscitation, cardiology, dialysis, etc) providing special levels of treatment and aimed therapies.

ACCESSORIES

Available upon request a series of dedicated accessories.

Please ask for the detailed catalogue for specific reference.

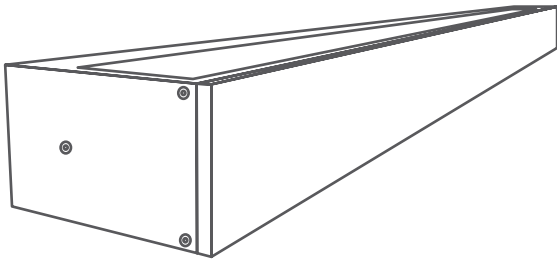

FLUO/LED LAMP

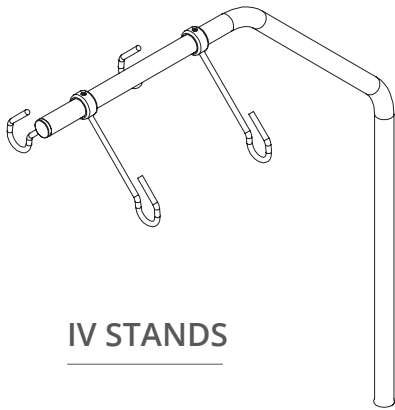

IV STANDS

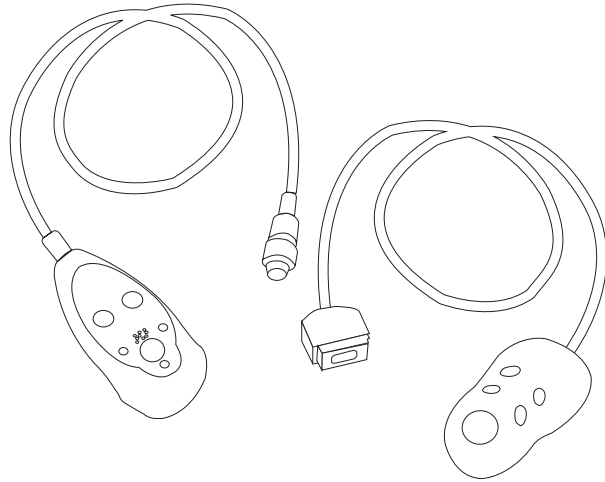

HANDSET FOR NURSE CALL AND LIGHTING CONTROL

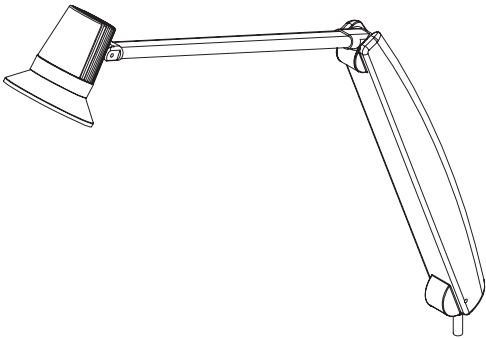

EXAMINATION LAMP

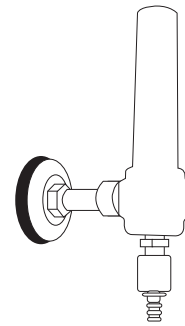

GAS OUTLETS

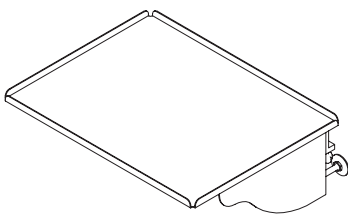

SHELVES AND DRAWERS

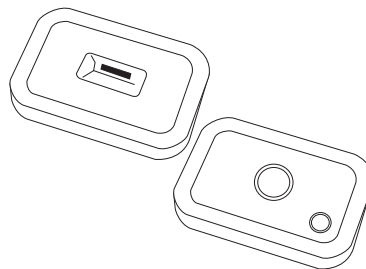

NURSE CALL

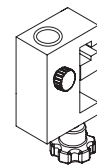

RAIL CLAMPS

GENERAL SPECIFICATIONS

- THE ELECTRICAL WIRES ARE ALWAYS KEPT IN DIFFERENT COMPARTMENTS IN ORDER TO SEPARATE THE MAIN POWER (110 ÷ 230 V) AND LOW VOLTAGE (12/24V).
- ON THE REAR SIDE OF THE BED HEAD UNIT THERE IS THE LOCATION FOR THE ELECTRICAL CABLES TO BE CONNECTED TO THE MAIN POWER PLUG ON THE WALL.
- THE LIGHTS ARE PROTECTED BY A SPECIAL POLYCARBONATE COVER TO GUARANTEE ADEQUATE LIGHT DIFFUSION.
- THE MAXIMUM LENGTH OF A SINGLE UNIT IS 5000 mm. ALL UNITS CAN BE LINKED TOGETHER WHEN SPECIAL LENGTHS ARE REQUIRED.
- ALL MODELS CAN BE FULLY CUSTOMIZED IN SIZE AND CONFIGURATION ACCORDING TO EACH CUSTOMER'S REQUEST.
- WE CAN SUPPLY THE BED HEAD UNIT WITH THE GAS OUTLETS AND PRE-PIPING, INSTALLED AND FULLY TESTED IF NEEDED.
- ALL OUR BED HEAD UNITS ALLOW A SIMPLE AND EASY MAINTENANCE.
- 12 MONTHS WARRANTY FOR ALL THE COMPONENTS AND MANUFATORER'S DEFECTS. NO WARRANTY IS EXTENDED TO ALL OTHER COMPONENTS LIABLE TO DETERIORATE AND FOR DAMAGES CAUSED BY INAPPROPRIATE USAGE.

RECOGNIZED CERTIFICATIONS

High reliability with the whole supplying network, constant personnel training, focused fine-tuning of the production processes, steady product improvements and commercial dependability have allowed us to obtain in a very short time the following broadly recognized quality system certifications:

- ISO 9001:2008

QUALITY MANAGEMENT SYSTEMS

- EN ISO 13485:2012

MEDICAL DEVICES QUALITY MANAGEMENT SYSTEMS

- EC CERTIFICATE

FULL QUALITY ASSURANCE SYSTEM APPROVAL

CERTIFICATE

- GOST CERTIFICATE



ISO 9001:2008
N° 9120.LMMD



REG. N. IT-79003



EN ISO 13485:2012
N° 9124.LMM2





CSQ MED
www.csq.it

CERTIFICATO N. 9124.LMM2
CERTIFICATE N.

SI CERTIFICA CHE IL SISTEMA QUALITÀ DI
WE HEREBY CERTIFY THAT THE QUALITY SYSTEM OPERATED BY

LM MEDICAL DIVISION SRL
VIA BORNICO SNC - FRAZ. S. PANCRAZIO - 25036 PALAZZOLO SULL'OGLIO (BS)
UNITÀ OPERATIVE
OPERATIVE UNITS
VIA BORNICO SNC - FRAZ. S. PANCRAZIO - 25036 PALAZZOLO SULL'OGLIO (BS)
È CONFORME ALLA NORMA
IS IN COMPLIANCE WITH THE STANDARD

EN ISO 13485:2012
PER LE SEGUENTI ATTIVITÀ
FOR THE FOLLOWING ACTIVITIES

Progettazione, produzione di prodotti elettromedicali ed arredi
Design, manufacturing of electro medical equipment and furniture
Certificazione basata in conformità al Regolamento Tecnico EN60601-1-2

IL PRESENTE CERTIFICATO È SOGGETTO AL RISPETTO DEL
REGOLAMENTO PER LA CERTIFICAZIONE DEI SISTEMI DI GESTIONE
THE USE AND THE VALIDITY OF THE CERTIFICATE SHALL SATISFY THE
REQUIREMENTS OF THE RULES FOR CERTIFICATION OF MANAGEMENT SYSTEMS

DATA DATE	REVISIONI/AGGIORNAMENTI REVISIONS/UPDATES	SCADENZA EXPIRES
2012-10-25	2013-06-13	2015-10-31

Marchi
REG. S.p.A. - VIA QUARTUCCIO, 45 - 25100 BRESCIA (BS) ITALY

CSQ is a member of **IQNet**
www.iqnet-certification.com

When the expiration date of the certificate arrives, a 90-day period of suspension of the certificate is provided. In case of non-compliance with the standard, the certificate is suspended until the non-compliance is corrected. All over the globe.

When the expiration date of the certificate arrives, a 90-day period of suspension of the certificate is provided. In case of non-compliance with the standard, the certificate is suspended until the non-compliance is corrected. All over the globe.

CSQ
www.csq.it

EA 19



EC CERTIFICATE
Certificate No 1548M00

Full Quality Assurance System Approval Certificate

On the basis of our examination carried out according to Annex II of the Directive 93/42/EEC and its revised version, we hereby certify that

LM MEDICAL DIVISION SRL
25036 PALAZZOLO SULL'OGLIO (BS) - VIA BORNICO SNC - FRAZ. S. PANCRAZIO (ITA) - Italy
manages in the factory of
25036 PALAZZOLO SULL'OGLIO (BS) - VIA BORNICO SNC - FRAZ. S. PANCRAZIO (ITA) - Italy
a full quality assurance system ensuring the conformity of the following products

Medical supply units
Series OKI Type ref. BASIC, BASIC GAS, BASIC GAS SOSPESA, PLUS, PLUS SOSPESA, FANTASY, VERTICAL, DESIGN, FLAT, QUADRO, CIELO
Trade mark LM

with the relevant essential requirements of the aforementioned directive (from design to final inspection and MDRG).

Reference to MQ Nos. No: 10AAR0018

This Approval Certificate is issued by RAQ S.p.A. as Notified Body for the Directive 93/42/EEC and its revised version.
Notified Body notified to European Commission under number: 2007.

Date: 2012-07-26

Marchi
IMQ

The Approval Certificate is subject to the provisions laid down in the Rules for managing the EC Certification of Medical Devices on the basis of the Directive 93/42/EEC.
In any case, it does not remain valid after 2017-07-20 (article 11, clause 11 of the Directive).

This is a translation of the Italian text, which prevails in case of doubt.

IMQ



CSQ
www.csq.it

CERTIFICATO N. 9120.LMMD
CERTIFICATE N.

SI CERTIFICA CHE IL SISTEMA QUALITÀ DI
WE HEREBY CERTIFY THAT THE QUALITY SYSTEM OPERATED BY

LM MEDICAL DIVISION SRL
VIA BORNICO SNC - FRAZ. S. PANCRAZIO - 25036 PALAZZOLO SULL'OGLIO (BS)
UNITÀ OPERATIVE
OPERATIVE UNITS
VIA BORNICO SNC - FRAZ. S. PANCRAZIO - 25036 PALAZZOLO SULL'OGLIO (BS)
È CONFORME ALLA NORMA
IS IN COMPLIANCE WITH THE STANDARD

ISO 9001:2008
PER LE SEGUENTI ATTIVITÀ
FOR THE FOLLOWING ACTIVITIES

Progettazione, produzione di prodotti elettromedicali ed arredi
Design, manufacturing of electro medical equipment and furniture
Riferirsi al manuale della qualità per l'implementazione dei requisiti della norma ISO 9001:2008
Refer to quality manual for details of application to ISO 9001:2008 requirements

IL PRESENTE CERTIFICATO È SOGGETTO AL RISPETTO DEL
REGOLAMENTO PER LA CERTIFICAZIONE DEI SISTEMI DI GESTIONE
THE USE AND THE VALIDITY OF THE CERTIFICATE SHALL SATISFY THE
REQUIREMENTS OF THE RULES FOR CERTIFICATION OF MANAGEMENT SYSTEMS

DATA DATE	REVISIONI/AGGIORNAMENTI REVISIONS/UPDATES	SCADENZA EXPIRES
2011-06-27	2013-06-13	2014-06-26

Marchi
REG. S.p.A. - VIA QUARTUCCIO, 45 - 25100 BRESCIA (BS) ITALY

CSQ is a member of **IQNet**
www.iqnet-certification.com

When the expiration date of the certificate arrives, a 90-day period of suspension of the certificate is provided. In case of non-compliance with the standard, the certificate is suspended until the non-compliance is corrected. All over the globe.

When the expiration date of the certificate arrives, a 90-day period of suspension of the certificate is provided. In case of non-compliance with the standard, the certificate is suspended until the non-compliance is corrected. All over the globe.

CSQ
www.csq.it

EA 19



IQNet
THE INTERNATIONAL CERTIFICATION NETWORK

CERTIFICATE

IQNet and its partner **CSQ/IMQ-CSQ** hereby certify that the organization

LM MEDICAL DIVISION SRL
VIA BORNICO SNC - FRAZ. S. PANCRAZIO - 25036 PALAZZOLO SULL'OGLIO (BS)

for the following field of activities

Design, manufacturing of electro-medical equipment and furniture
Refer to quality manual for details of application to ISO 9001:2008 requirements
has implemented and maintains a **Quality Management System** which fulfills the requirements of the following standard

ISO 9001:2008
Issued on: 2013 - 06 - 13 Expiry date: 2014 - 06 - 25

Registration Number: IT - 79003

IQNet *Marchi* **CSQ** *Marchi*
Michael Develin President of IQNET Ing. Claudio Proietti President of CSQ

AENOR Spain AFNOR Certification France ABN-Vrijheid International Belgium ENCE-DEE Belgium APCER Portugal/CEC Cyprus CRJ Aub-CQC China CCM-C Sino CCR-Czech Republic Cex-Cert Canada DKN Holding GmbH Germany EN-Forum EU-IV Brazil FONDONORMA Slovakia IQNTEC Colombia IMC Mexico DNORP1 Russia Inspira Certification/Falcom/BAVM Argentina RQA Japan KPO Korea NITEC Greece MMT Hongkong Nambu AS Korea NVA-Ed Ireland PCBC Poland Quality Assesma Slovakia R3 Bureau AU Brazil IQI Slovenia NIRMQA Quality International Maldives RQR International BRAC Azerbaijan TEST in Romania Romania TSE Turkey YIQAQ Serbia IQNet is represented in the USA by AFNOR Certification, CSQ, OQS (Quality Control) and SQA Inc.

* The list of IQNet partners is valid at the time of issue of this certificate. Updated information is available under www.iqnet-certification.com